

## TORNIQUETES ÓPTICOS DESLIZANTES MODELO DG 870

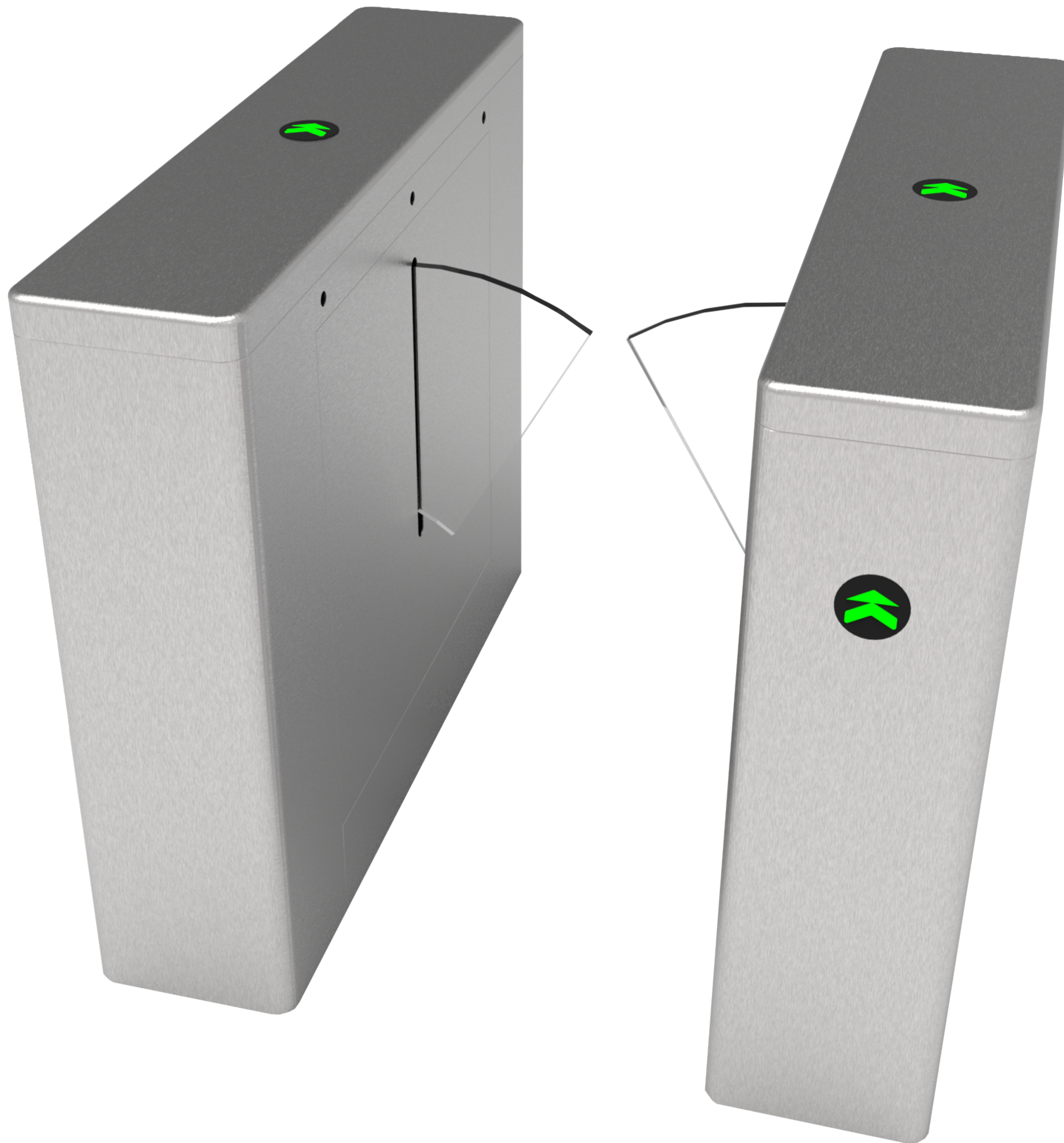

### INSTALACIONES

Se pueden fabricar en acero inoxidable y al carbón



Estaciones de metro

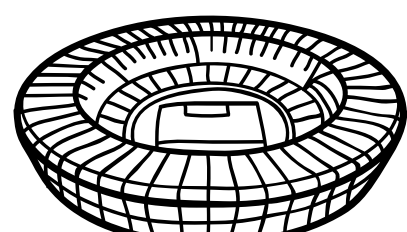

Estadios deportivos



Empresas y condominios

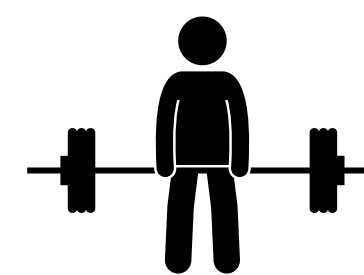

Gimnasios



Instituciones educativas



Fabricado en acero inoxidable en su totalidad, pictogramas de señalización y puertas deslizantes en forma de aleta, de acrílico o cristal templado.

## Características:

**Mecanismo:** Mecanismo siempre abierto

**Material:** Acero inoxidable calibre 16 tipo 304

**Puertas:** Acrílico transparente de 9mm

**Tapa superior:** Placa de acrílico negro

**Alimentación:** 110 - 120 AC

**Consumo:** 120 W

**Operación de solenoides:** 12 Volts

**Ambiente de trabajo:** Interior/Exterior

**Dimensiones:** 101x29cm

**Peso:** 70 Kg

### Tipos de accionamiento

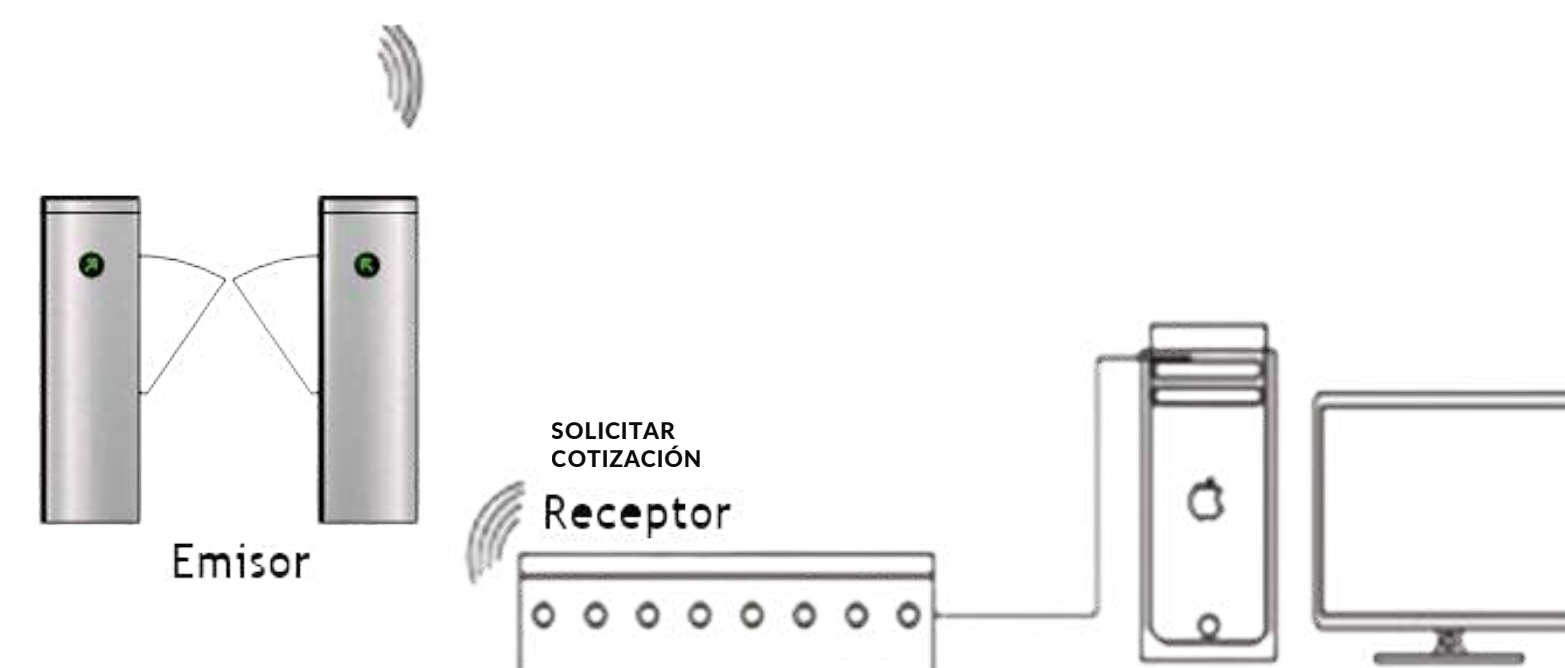
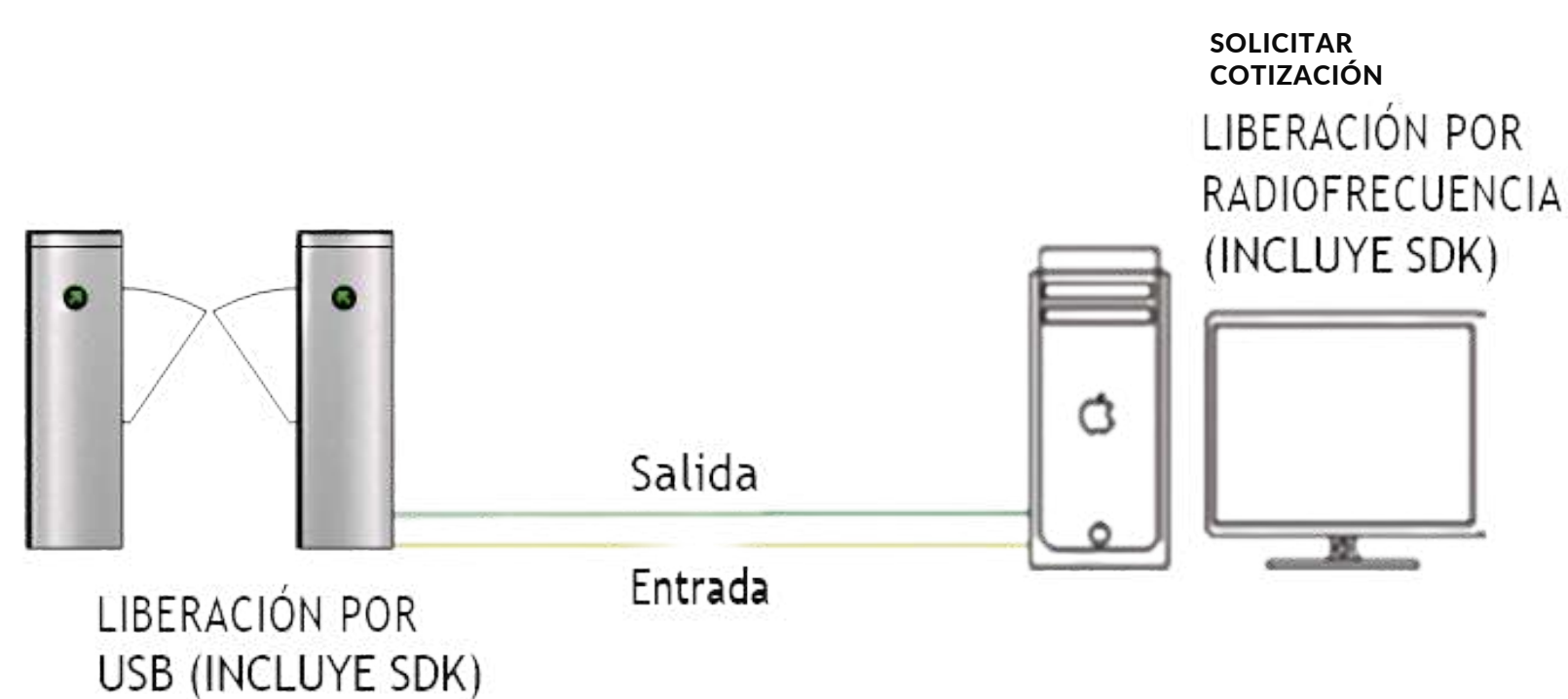
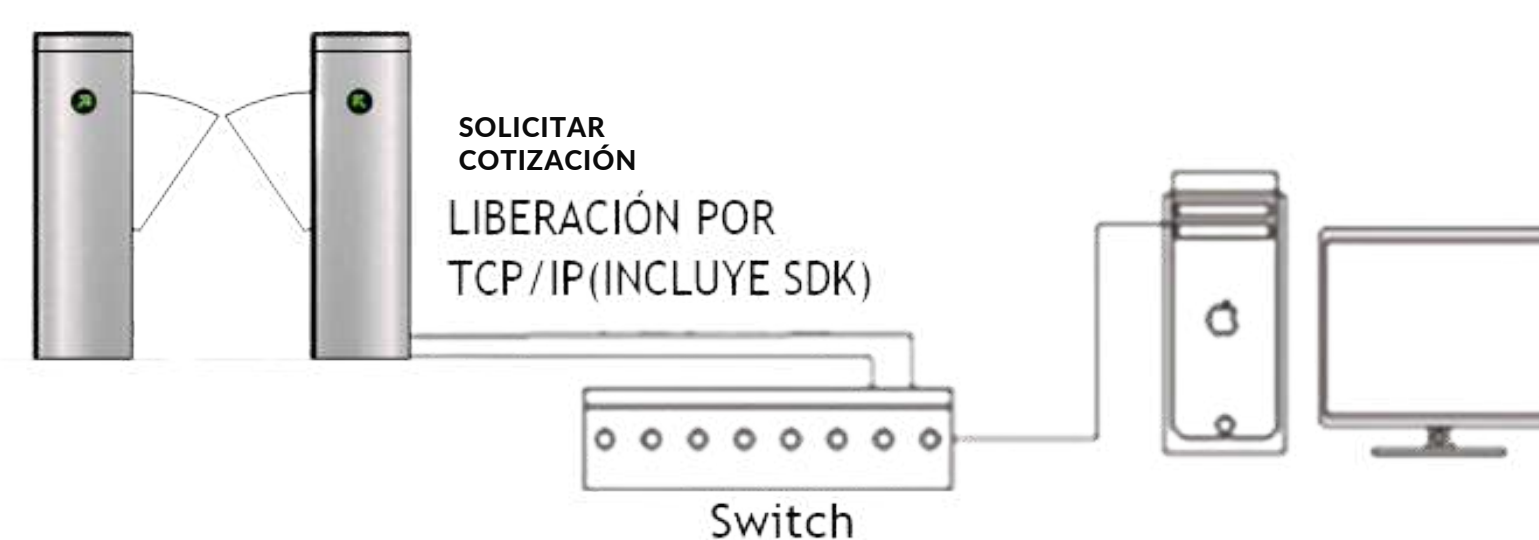
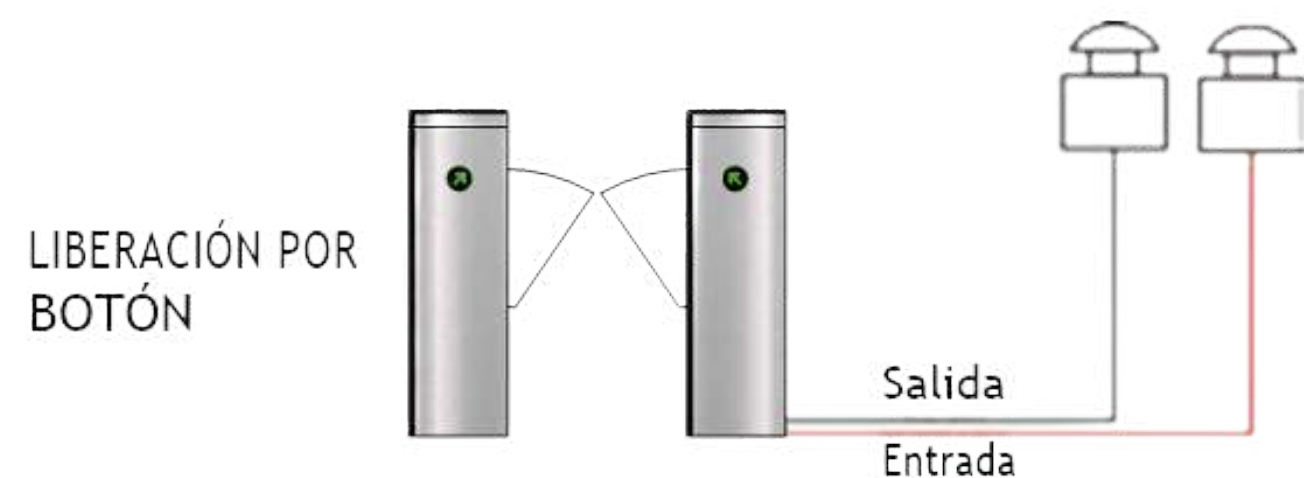

## Medidas:

### Dimensiones (cm)

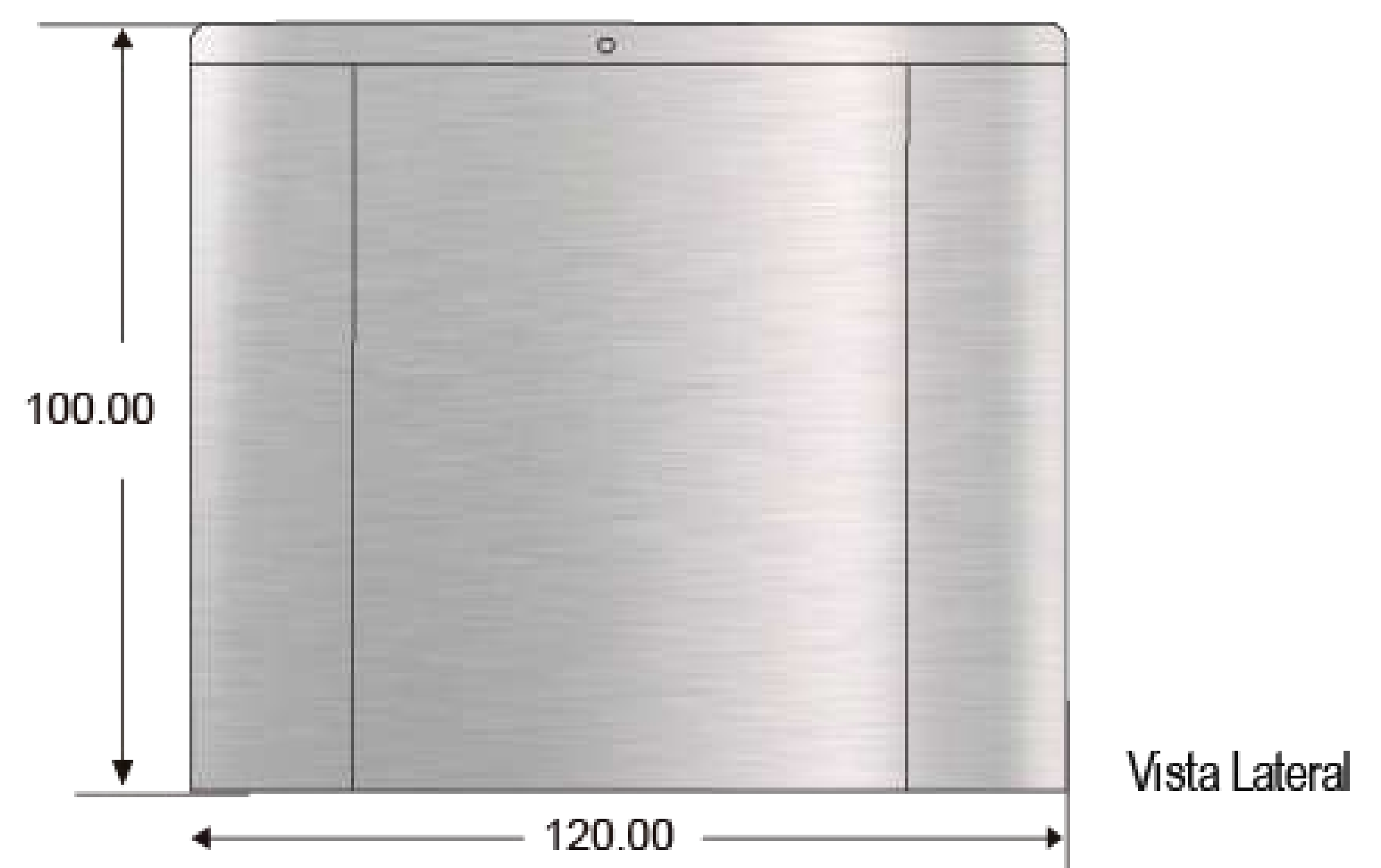
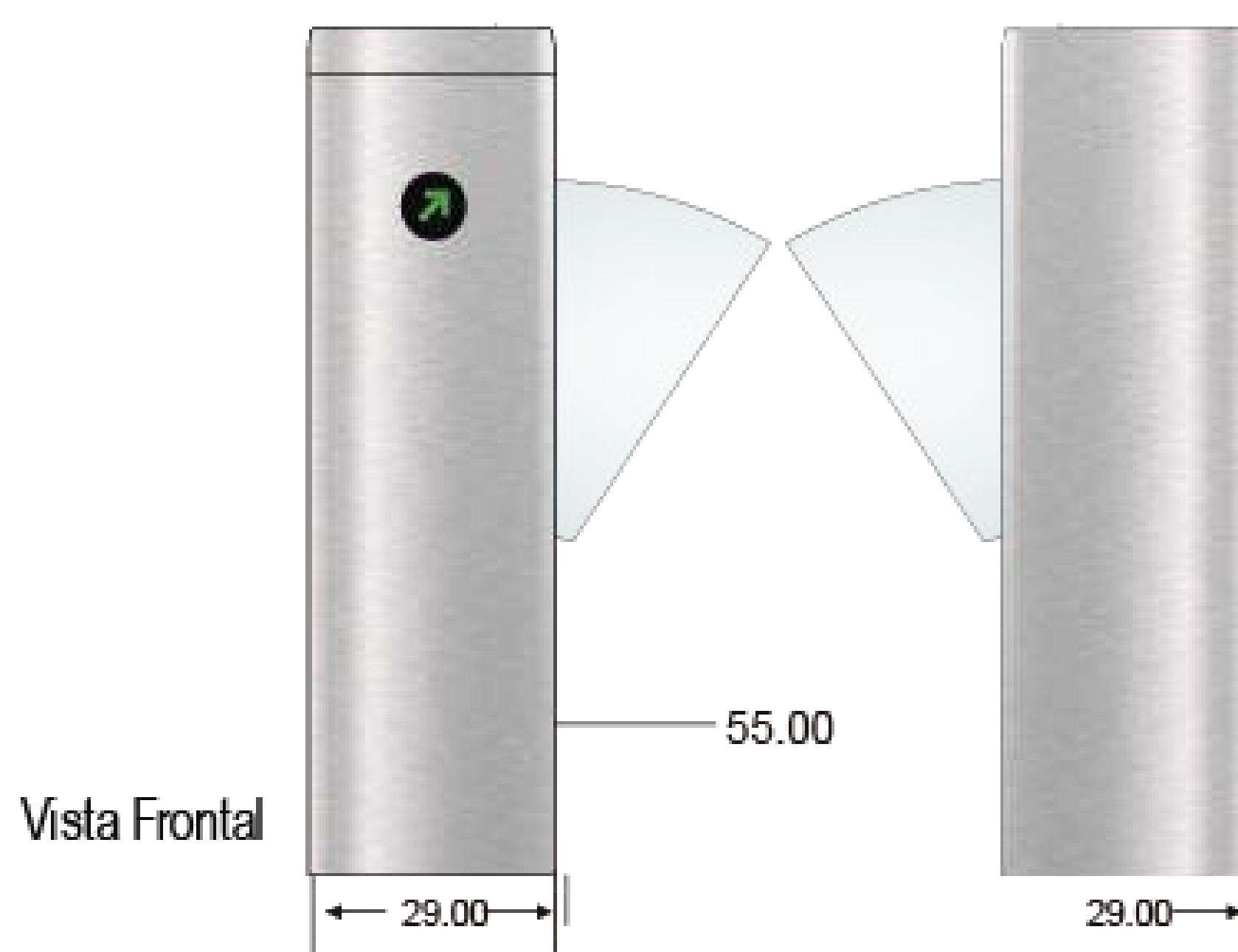

## CONTROL DE ACCESO



Lector de código QR

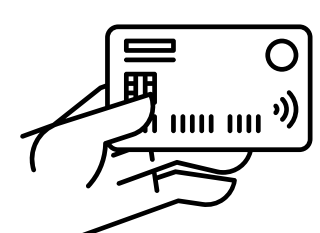

Lector Smart card

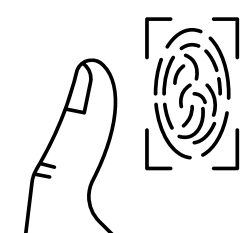

Lector biométrico

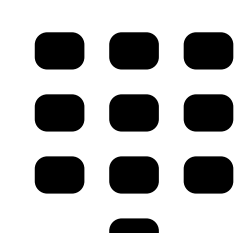

Teclado numérico

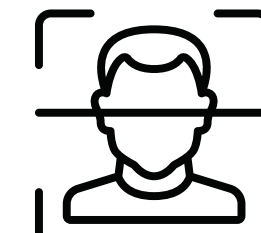

Reconocimiento facial